

veto[®]

Catálogo de Productos



veto®



VETO es una marca de clase mundial dedicada a la fabricación de material eléctrico desde hace más de 50 años. La excelencia de sus productos son el resultado de la extensa experiencia alcanzada a través del tiempo ubicándola a la vanguardia de la innovación, diseño y calidad respaldada por una garantía de 10 años.



INDICE



Plura ▶ 5

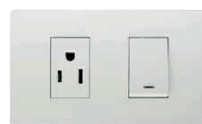

Premiun ▶ 20



Plata ▶ 27



Vive ▶ 34



Nieve ▶ 41



Click ▶ 45



Accesorios ▶ 48



Power ▶ 51

veto[®]



 [®] Plura

www.vetoelectric.com



CARACTERÍSTICAS

- Diseño exclusivo
- Sistema modular (Tacos y Placas)
- Sistema de luz piloto LED
- Interruptores 125/250 Vac 16 Amp
- Tomacorrientes 125/250 Vac 15 Amp
- Amplia variedad de colores y materiales

CERTIFICACIONES

- Certificación que cumple con la Norma IEC 60669-1 (Interruptores)
- IEC 60884-1 (Tomacorrientes)

DIAGRAMA DE INSTALACIÓN

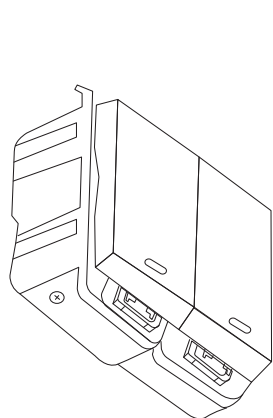

MÓDULOS

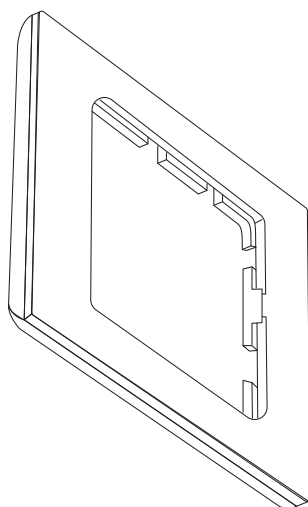

PLACA

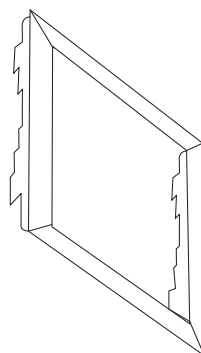

MARCO DECORATIVO

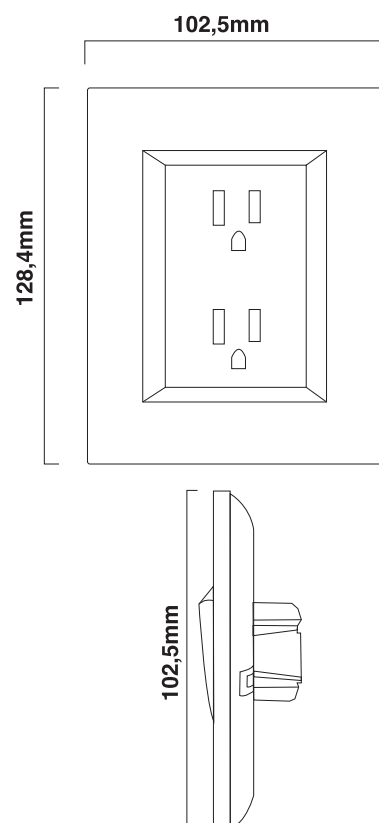

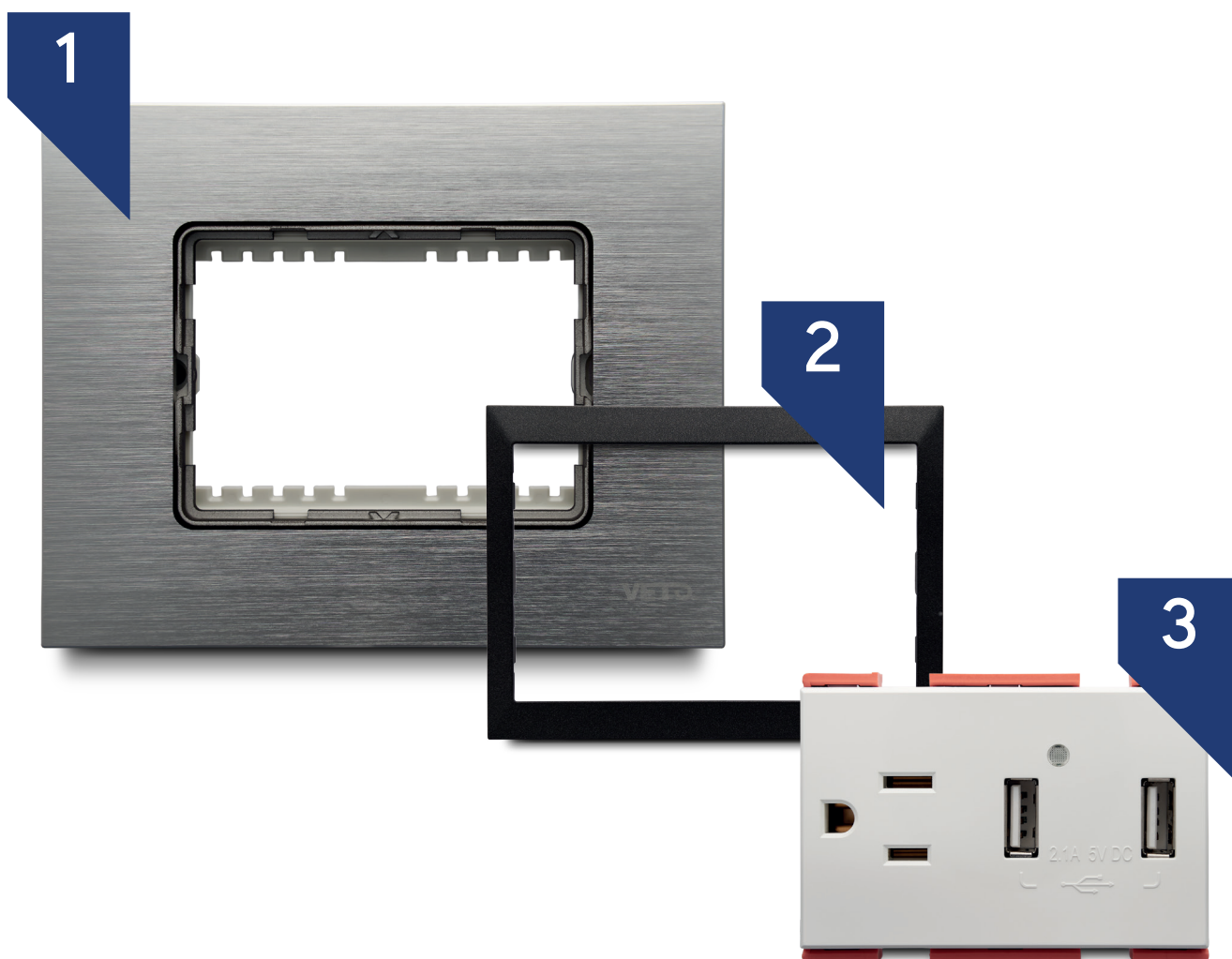

1. Selecciona tu placa favorita
2. Combínala con el marco que más te guste
3. Escoge qué módulos necesitas

Plástico

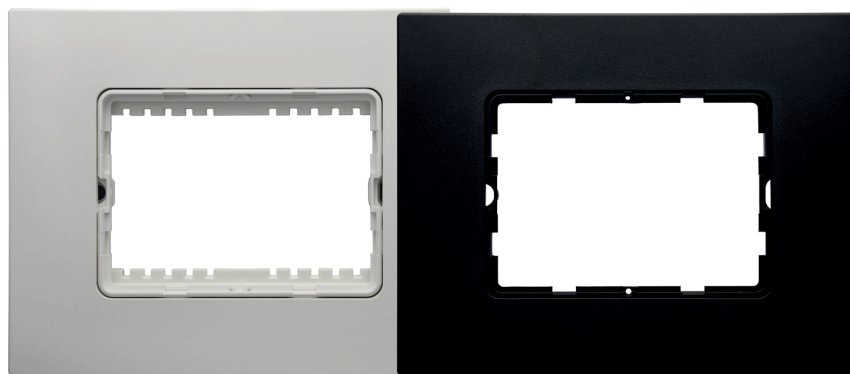

Placa Blanca Plástico
PLU60088

Placa Negra Plástico
Próximamente

Metales

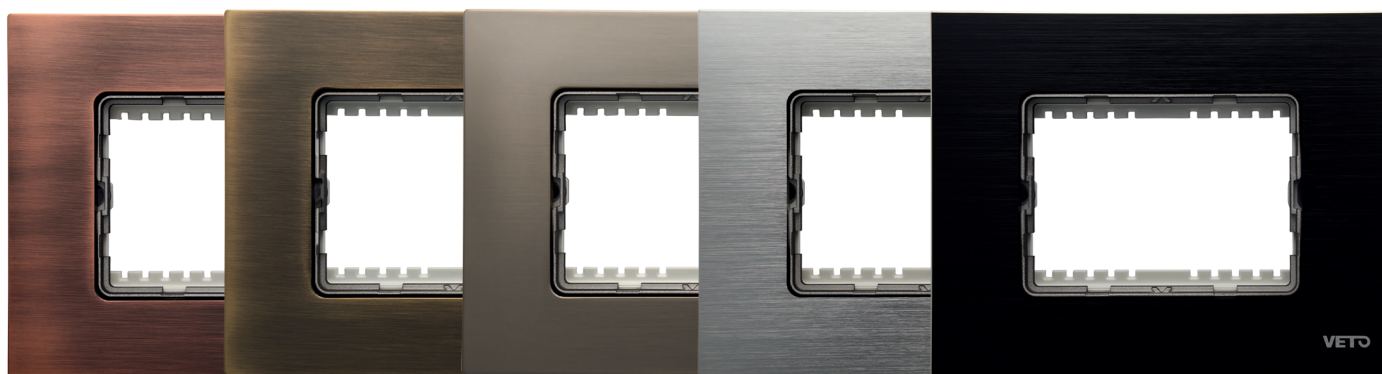

Placa Cobre
PLU60064

Placa Bronce
PLU60071

Placa Acero
PLU60057

Placa Aluminio Plura
PLU60033

Placa Aluminio Negro
PLU60040

Vidrio



Placa Vidrio Verde
PLU60026

Placa Vidrio Negro
PLU60002

Placa Vidrio Blanco
PLU60019

Marcos

Marco Blanco
PLU60095

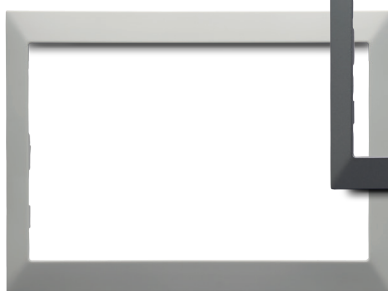

Marco Plura
PLU60101



Marco Negro
PLU60118



Módulos

24 mm

Interrupor 16 Amp
PLU60125
Conmutador 16 Amp
PLU60132
4vías 16 Amp
PLU60156



36 mm

Interrupor 16 Amp
PLU60163
Conmutador 16 Amp
PLU60170
4vías 16 Amp
PLU60194



72 mm

Interrupor 16 Amp
PLU60200
Conmutador 16 Amp
PLU60217
4vías 16 Amp
PLU60231



Interrupor 16 Amp
PLU60361
Conmutador 16 Amp
PLU60378
4vías 16 Amp
PLU60392



Interrupor 16 Amp
PLU60408
Conmutador 16 Amp
PLU60415
4vías 16 Amp
PLU60439

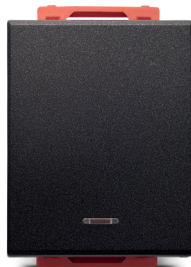

Interrupor 16 Amp
PLU60446
Conmutador 16 Amp
PLU60453
4vías 16 Amp
PLU60477





Tomacorriente 36mm

BL	PLU60255
NG	PLU60491



Tomacorriente Doble 72mm

BL	PLU60248
NG	PLU60484

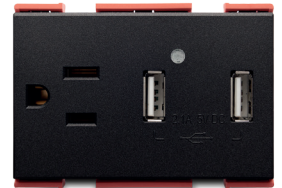

Tomacorriente + Usb 72mm

BL	PLU60323
NG	PLU60569



Tomacorriente Univ 36mm

BL	PLU60910
NG	PLU60927



Tomacorriente Doble Univ 72mm

BL	PLU60262
NG	PLU60507



Dimmer 36mm 400 W

BL	PLU60309
NG	PLU60545



Hdmi 36mm tipo A

BL	PLU60354
NG	PLU60590



Usb 36mm 2.1 Amp

BL	PLU60330
NG	PLU60576



Coaxial 36mm 75 Ohms

BL	PLU60279
NG	PLU60514

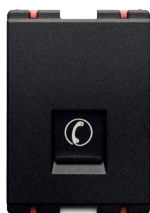

Jack Teléfono 36mm RJ25

BL	PLU60286
NG	PLU60521



Jack Datos 36mm RJ45 Cat 6A

BL	PLU60293
NG	PLU60538

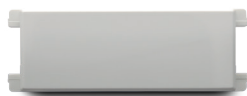

Tapa Cubre Hueco 18mm

BL	PLU60699
NG	PLU60668



Tapa Cubre Hueco 24mm

BL	PLU60705
NG	PLU60675



Tapa Cubre Hueco 36mm

BL	PLU60712
NG	PLU60682



Pulsador Timbre 36mm

BL	PLU60187
NG	PLU60422



Pulsador Timbre 72mm

BL	PLU60224
NG	PLU60460



Tomacorriente Doble

ARMADO BL PLU60880
ARMADO NG PLU61917

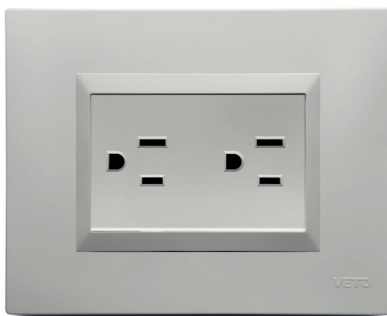

Interrupor Simple

ARMADO BL PLU60729
ARMADO NG PLU61801

Conmutador

ARMADO BL PLU60774
ARMADO NG PLU61832

Conmutador 4 Vías

ARMADO BL PLU60804
ARMADO NG PLU61870

Interrupor Doble 16 Amp

ARMADO BL PLU60736
ARMADO NG PLU61818

Conmutador

ARMADO BL PLU60781
ARMADO NG PLU61900

Interrupor + Conmutador

ARMADO BL PLU60750
ARMADO NG PLU61894

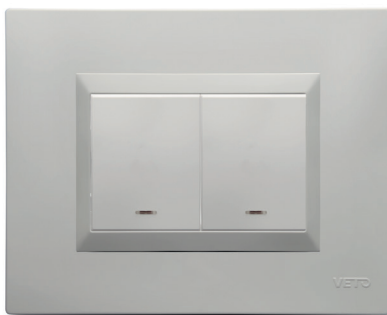

Interrupor Triple

ARMADO BL PLU60743
ARMADO NG PLU61825

Conmutador

ARMADO BL PLU60798
ARMADO NG PLU61856

Tomacorriente + Interrupor

ARMADO BL PLU60766
ARMADO NG PLU61849

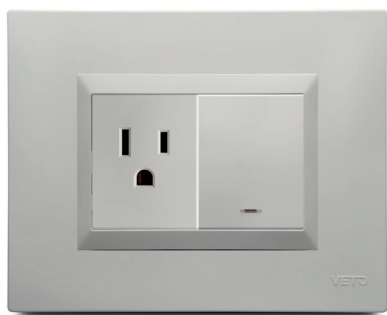

Coaxial 75 Ohms

ARMADO BL PLU60873
ARMADO NG PLU61948

Jack Teléfono Simple RJ25

ARMADO BL PLU60811
ARMADO NG PLU61924



Jack Teléfono Doble RJ25

ARMADO BL PLU60828
ARMADO NG PLU61979



Jack Datos Simple RJ45Cat6A

ARMADO BL PLU60842
ARMADO NG PLU61863

Jack Datos Doble

ARMADO BL PLU60859
ARMADO NG PLU61887

Dimmer 400 W

ARMADO BL PLU60897
ARMADO NG PLU61955

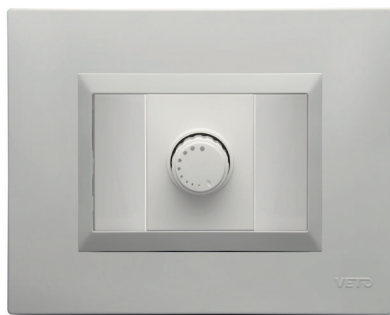

Coaxial + Jack Teléfono

ARMADO BL PLU60835
ARMADO NG PLU61962

Pulsador de Timbre

ARMADO BL PLU60866
ARMADO NG PLU61931



Tomacorriente + USB 2.1 Amp

ARMADO BL PLU60903
ARMADO NG PLU61986

Combinaciones

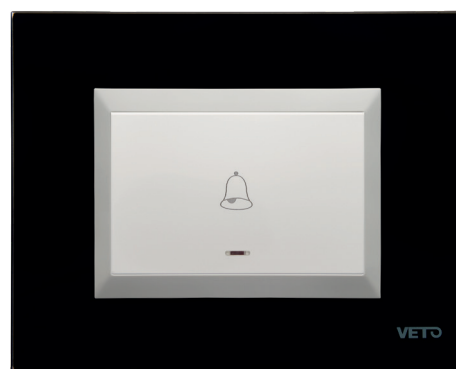

Combinaciones

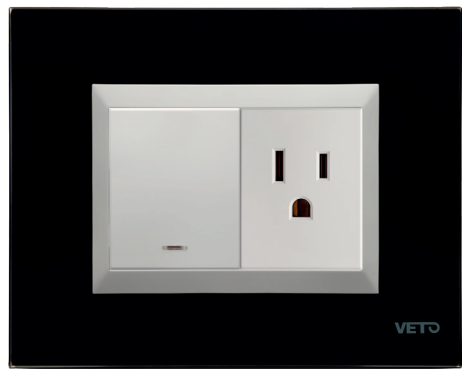

Combinaciones

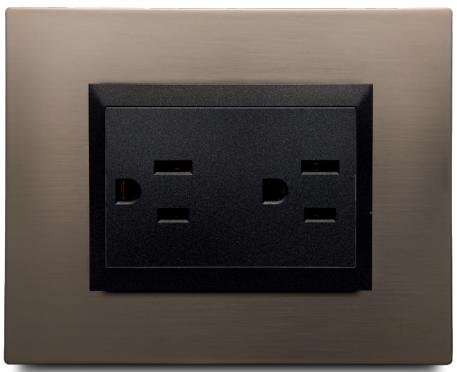



Convierte tu casa en un hogar inteligente de una manera fácil y alcanzable



Tarjeta inteligente

BroadLink

Compatible con



®

Plura Smart

Interruptor Simple

NEGRO PLU60613



Interruptor Simple

BLANCO PLU60606



Interruptor Doble

NEGRO PLU60637



Interruptor Doble

BLANCO PLU60620



Interruptor Triple

NEGRO PLU60651



Interruptor Triple

BLANCO PLU60644

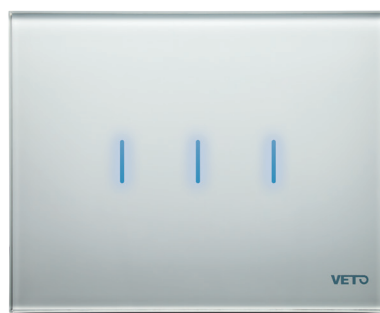

veto®

Plura®

BroadLink

Remoto Inteligente
Universal
Rango 8-10 m
RM PRO BRO55008



Remoto Inteligente
Universal
Rango 6-8 m
RM MINI BRM55015



Tomacorriente Inteligente
SP3 BRO55022



Con Plura Smart

- ▶ No necesita cableado, solo reemplaza por el interruptor tradicional.
- ▶ Controla todos tus dispositivos electrónicos desde nuestra aplicación.
- ▶ Aplicación compatible con IOS y Android.
- ▶ Tecnología compatible con Amazon Alexa y Google Home.

veto VETO VETO VETO

50 años

10 años GARANTÍA

veto[®]



 [®]
Premium

www.vetoelectric.com



CARACTERÍSTICAS

- Sistema modular (Tacos y Placas)
- Bastidor metálico que evita deformaciones
- Interruptores 125/250 Vac 15 Amp
- Tomacorrientes 125/250 Vac 15 Amp
- La luz piloto de nuestros productos no produce destellos al utilizarse con focos ahorradores
- Termopolímero de última generación

CERTIFICACIONES

- Certificación que cumple con la Norma IEC 60669-1 (Interruptores)
- IEC 60884-1 (Tomacorrientes)

DIAGRAMA DE INSTALACIÓN

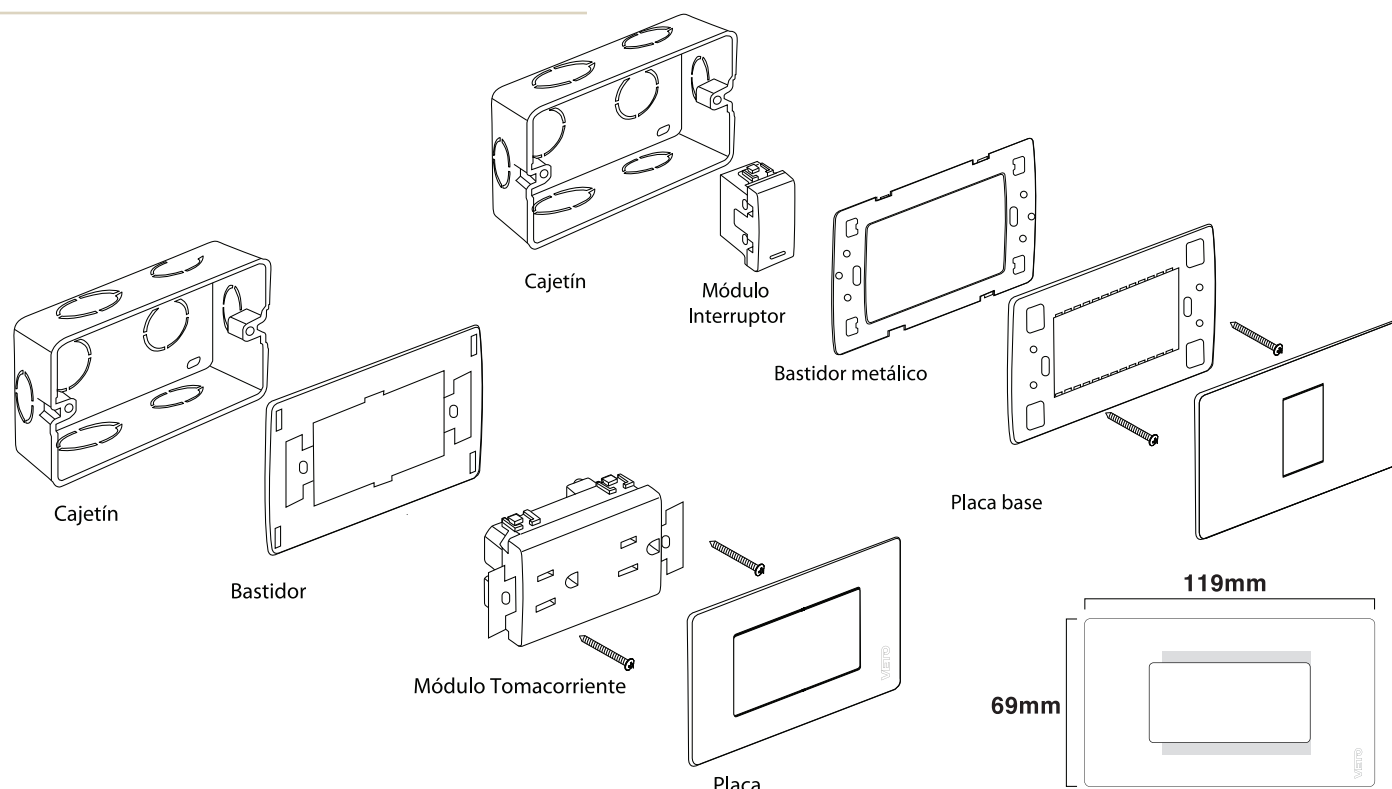
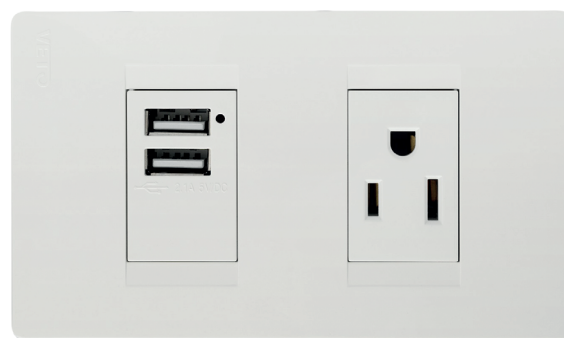



Placa 1 Hueco

BLANCO	PRE16405
MARFIL	PRE18379

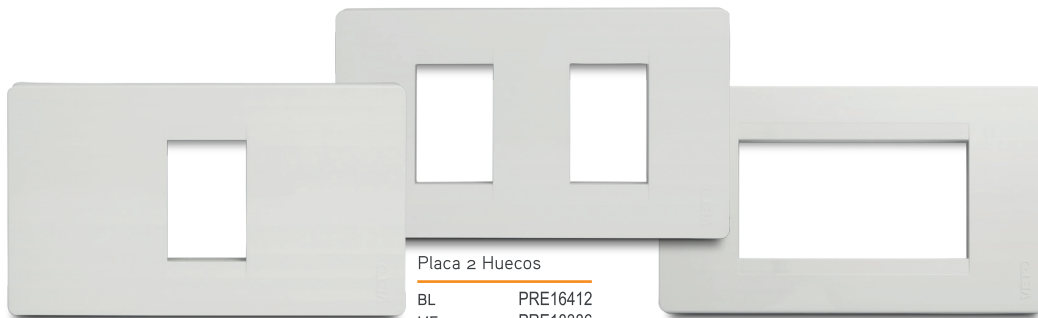

Placa 3 Huecos

BL	PRE16429
MF	PRE18393

Placa 2 Huecos

BL	PRE16412
MF	PRE18386

Placa 1 Hueco

COBRE	PRE15200
-------	----------



Placa 3 huecos

COBRE	PRE15224
-------	----------

Placa Tomacorriente

COBRE	PRE15231
-------	----------

Placa 2 Huecos

COBRE	PRE15217
-------	----------

Placa 1 Hueco

GRAFITO	PRE15248
---------	----------



Placa 3 Huecos

GRAFITO	PRE15262
---------	----------

Placa Tomacorriente

GRAFITO	PRE15279
---------	----------

Placa 2 Huecos

GRAFITO	PRE15255
---------	----------

Placa 1 Hueco

PLATEADA	PRE15286
----------	----------



Placa 3 Huecos

PLATEADA	PRE15309
----------	----------

Placa Tomacorriente

PLATEADA	PRE15316
----------	----------

Placa 2 Huecos

PLATEADA	PRE15293
----------	----------

Interrupor 15 Amp

ARMADO BL PRE16023
 ARMADO MF PRE18010
 MÓDULO BL PRE16078
 MÓDULO MF PRE18065

Conmutador 15 Amp

ARMADO BL PRE16085
 ARMADO MF PRE18072
 MÓDULO BL PRE16122
 MÓDULO MF PRE18119

Conmutador 4 Vías 15 Amp

ARMADO BL PRE16146
 ARMADO MF PRE18133
 MÓDULO BL PRE16139
 MÓDULO MF PRE18126

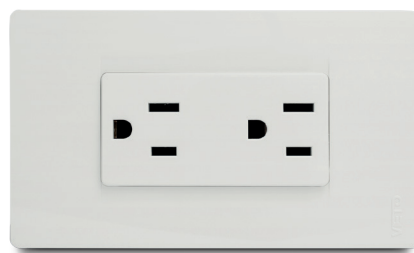

Tomacorriente Doble 15 Amp

ARMADO BL PRE16382
 ARMADO MF PRE18355

Interrupor Doble 15 Amp

ARMADO BL PRE16047
 ARMADO MF PRE18034

Conmutador Doble 15 Amp

ARMADO BL PRE16108
 ARMADO MF PRE18096

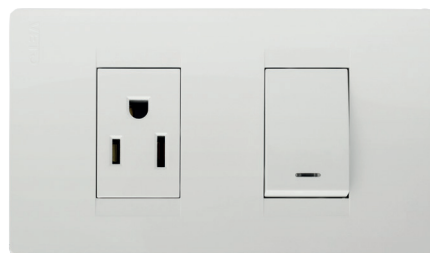
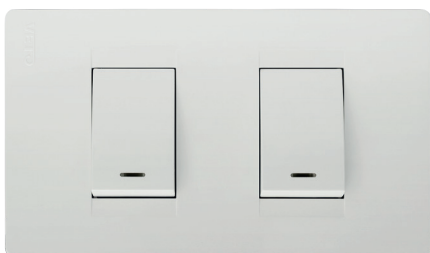

Tomacorriente + Interrupor

ARMADO BL PRE16061
 ARMADO MF PRE18058

Tomacorriente

MÓDULO BL PRE16191
 MÓDULO MF PRE18188

Interrupor

MÓDULO BL PRE16078
 MÓDULO MF PRE18065

Interrupor Triple 15 Amp

ARMADO BL PRE16054
 ARMADO MF PRE18065

Conmutador Triple 15 Amp

ARMADO BL PRE16115
 ARMADO MF PRE18102

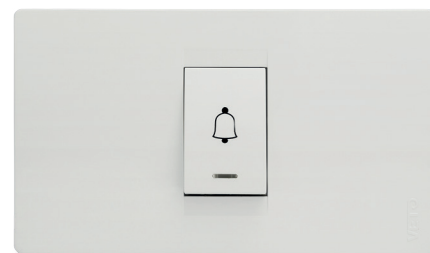

Pulsador Timbre

ARMADO BL PRE16290
 ARMADO MF PRE18461
 MÓDULO BL PRE16306
 MÓDULO MF PRE18478

Tomacorriente + Usb 2.1 Amp

ARMADO BL PRE16788
 ARMADO MF PRE18638

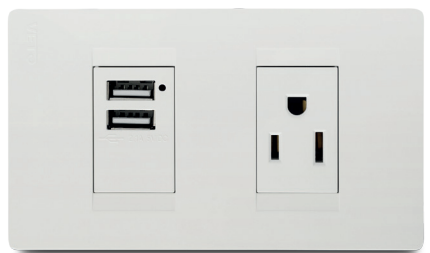

Tarjetero 30A

ARMADO BL PRE16917
 ARMADO MF PRE18751



Dimmer 400W

- ARMADO BL PRE16474
- ARMADO MF PRE28484
- MÓDULO BL PRE16344
- MÓDULO MF PRE18348



Tomacorriente GFCI

- ARMADO BL PRE 16511
- ARMADO MF PRE18484

Pasa Cables

- ARMADO BL PRE16467
- ARMADO MF PRE18423

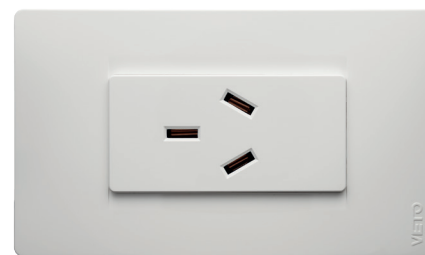

Tomacorriente Nema 10-20R

- ARMADO BL PRE16641
- ARMADO MF PRE18546

Tomacorriente Heavy Duty

- ARMADO BL PRE16993

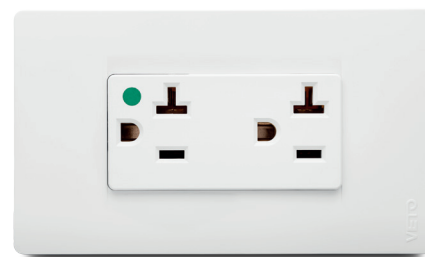

Tomacorriente Grado Hospitalario

- MÓDULO BL PRE16962
- MÓDULO MF PRE18805

Tomacorriente Night Light

Próximamente



Tomacorriente Nema 10-50

- ARMADO BL PRE16818
- ARMADO MF PRE18652

**Placa 6 huecos
con bastidor y chasis**

PLACA BL	PRE16436
PLACA MF	PRE18690

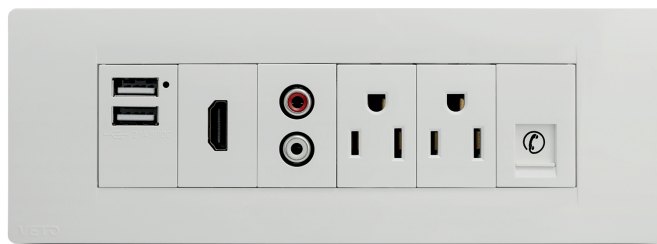

Interruptor Persianas

ARMADO BL	PRE16573
ARMADO MF	PRE18287
MÓDULO BL	PRE16566
MÓDULO MF	PRE18270



Zumbador

ARMADO BL	PRE16634
ARMADO MF	PRE18317
MÓDULO BL	PRE16528
MÓDULO MF	PRE18539



Jack de Datos RJ45 CAT6

MÓDULO BL	PRE16832
MÓDULO MF	PRE18256

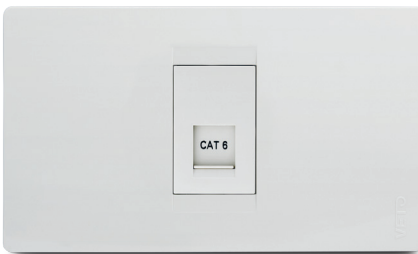

Jack Teléfono RJ14

MÓDULO BL	PRE16153
MÓDULO MF	PRE18140



Jack de Datos Simple

ARMADO BL	PRE16238
ARMADO MF	PRE18225

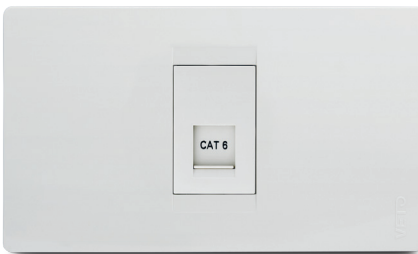

Jack Teléfono Simple

ARMADO BL	PRE16160
ARMADO MF	PRE18157

Jack de Datos Doble

ARMADO BL	PRE16245
ARMADO MF	PRE18232

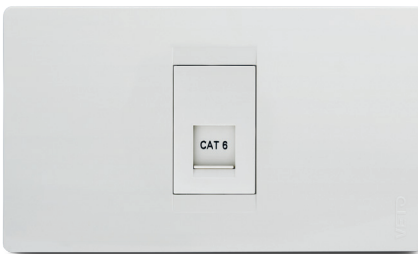

Jack Teléfono Doble

ARMADO BL	PRE16177
ARMADO MF	PRE18164

Coaxial

ARMADO BL	PRE16337
ARMADO MF	PRE18324
MÓDULO BL	PRE16320
MÓDULO MF	PRE18492



Coaxial + Jack Teléfono

ARMADO BL	PRE16184
ARMADO MF	PRE18171



HDMI Tipo A

MODULO BL	PRE16825
MODULO MF	PRE18669





Placa Ciega

ARMADO BL PRE16399
ARMADO MF PRE18362

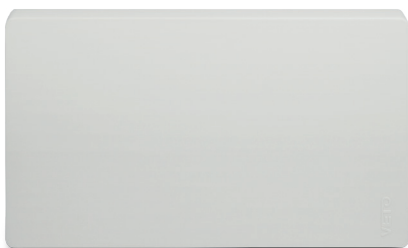

Conector Audio Simple

ARMADO BL PRE16276
ARMADO MF PRE18447

Conector Audio Doble

ARMADO BL PRE16283
ARMADO MF PRE18454



Tapa Exteriores

PRE16672



Tapa Exteriores con Tomacorriente GFCI

PRE28835



Tomacorriente Univ + USB

ARMADO BL PRE16535
ARMADO MF PRE18263



Tomacorriente Doble Univ

ARMADO BL PRE16658
ARMADO MF PRE18676



Tomacorriente Univ + Interruptor

ARMADO BL PRE16757
ARMADO MF PRE18607

Tomacorriente Univ

MÓDULO BL PRE16764
MÓDULO MF PRE18614



Tomacorriente Triple Univ

ARMADO BL PRE16726
ARMADO MF PRE18577



Placa Organizadora de Cables

PRÓXIMAMENTE



Interruptor + Shuko

ARMADO BL PRE16979
ARMADO MF PRE18112



veto®



 Plata®

www.vetoelectric.com



27

CARACTERÍSTICAS

- Sistema modular (Tacos y Placas)
- Contactos con punto de Plata
- Interruptores 125/250 Vac 10 Amp
- Tomacorrientes 125/250 Vac 15 Amp
- La luz piloto de nuestros productos no produce destellos al utilizarse con focos ahorradores
- Fabricado en Termopolímero de última generación

CERTIFICACIONES

- Certificación que cumple con la Norma IEC 60669-1 (Interruptores)
- IEC 60884-1 (Tomacorrientes)

DIAGRAMA DE INSTALACIÓN

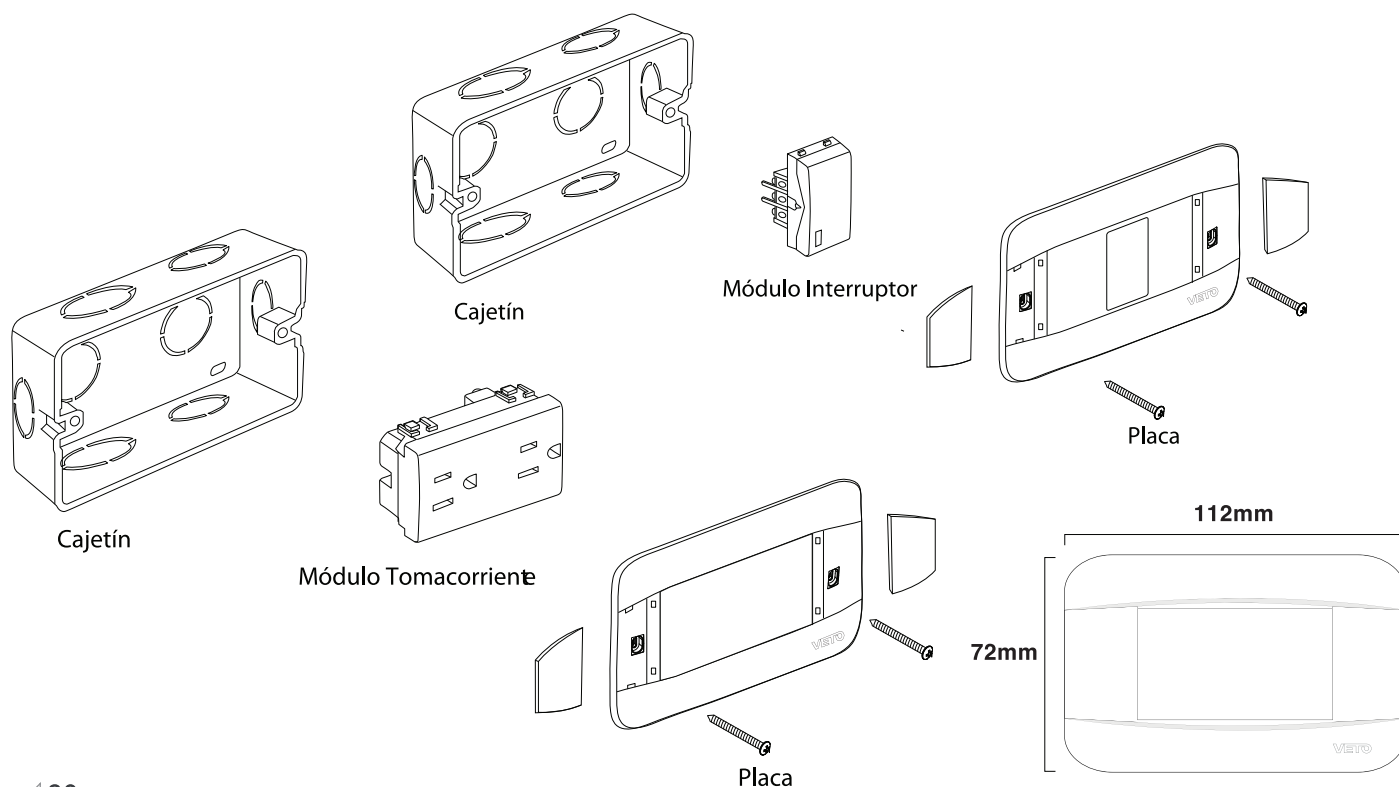



Placa 1 Huevo

ARMADO BL	PLA35505
ARMADO MF	PLA35512



Placa 3 Huecos

ARMADO BL	PLA35543
ARMADO MF	PLA35550

Placa 2 Huecos

ARMADO BL	PLA35529
ARMADO MF	PLA35536



Interruptor con Luz Piloto Simple 10Amp

ARMADO BL	PLA35109
ARMADO MF	PLA35116
MODULO BL	PLA35079
MODULO MF	PLA35086

Conmutador

ARMADO BL	PLA35208
ARMADO MF	PLA35215
MODULO BL	PLA35161
MODULO MF	PLA35178



Interruptor Simple 10Amp

ARMADO BL	PLA89997
ARMADO MF	PLA90160
MODULO BL	PLA89966
MODULO MF	PLA35901

Conmutador

ARMADO BL	PLA90108
ARMADO MF	PLA90177
MODULO BL	PLA89973
MODULO MF	PLA35918

Interruptor con Luz Piloto Doble 10Amp

ARMADO BL	PLA35123
ARMADO MF	PLA35130

Conmutador

ARMADO BL	PLA35222
ARMADO MF	PLA35239

Interrupto + Conmutador

ARMADO BL	PLA35185
ARMADO MF	PLA35635

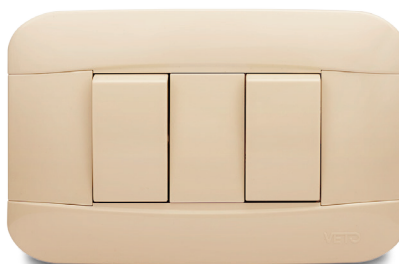

Interruptor Doble 10Amp

ARMADO BL	PLA90139
ARMADO MF	PLA90214

Conmutador

ARMADO BL	PLA90153
ARMADO MF	PLA90238

Interrupto + Conmutador

ARMADO BL	PLA35093
ARMADO MF	PLA90207

Interruptor con Luz Piloto Triple 10Amp

ARMADO BL	PLA35147
ARMADO MF	PLA35154

Conmutador

ARMADO BL	PLA35246
ARMADO MF	PLA35680



Interruptor Triple 10Amp

ARMADO BL	PLA90146
ARMADO MF	PLA90221

Conmutador

ARMADO BL	PLA90313
ARMADO MF	PLA90320

Tomacorriente Doble

ARMADO BL	PLA35352
ARMADO MF	PLA35369



Tomacorriente Doble Tierra Aislada

ARMADO	PLA90443
--------	----------

Tomacorriente + Interruptor con Luz Piloto

ARMADO BL	PLA35598
ARMADO MF	PLA35727
TOMACORRIENTE BL	PLA35017
TOMACORRIENTE MF	PLA35741
INTERRUPTOR BL	PLA35079
INTERRUPTOR MF	PLA35086



Tomacorriente + Interruptor

ARMADO BL	PLA90122
ARMADO MF	PLA90191
TOMACORRIENTE BL	PLA35017
TOMACORRIENTE MF	PLA35741
INTERRUPTOR BL	PLA89966
INTERRUPTOR MF	PLA35901

Jack Teléfono RJ14

ARMADO BL	PLA35284
ARMADO MF	PLA35277
MODULO BL	PLA35253
MODULO MF	PLA35260



Jack Teléfono RJ14

ARMADO BL	PLA35307
ARMADO MF	PLA35291
MODULO BL	PLA35253
MODULO MF	PLA35260

Dimmer 200W

ARMADO BL	PLA35055
ARMADO MF	PLA35659
MODULO BL	PLA35062
MODULO MF	PLA35666



Tomacorriente + Usb 2.1Amp

MODULO BL	PLA36465
MODULO MF	PLA36472



Pulsador de Timbre con Luz Piloto

ARMADO BL	PLA35420
ARMADO MF	PLA35437
MODULO BL	PLA35406
MODULO MF	PLA35413



Pulsador de Timbre

ARMADO BL	PLA90115
ARMADO MF	PLA90184
MODULO BL	PLA89980
MODULO MF	PLA35925

Coaxial + Jack Teléfono

ARMADO BL	PLA35314
ARMADO MF	PLA35765
COAXIAL BL	PLA35444
COAXIAL MF	PLA35451
JACK BL	PLA35253
JACK MF	PLA35260



Coaxial 65 Ohms

ARMADO BL	PLA35475
ARMADO MF	PLA35468
MODULO BL	PLA35444
MODULO MF	PLA35451

Jack Datos Simple CAT6

ARMADO BL	PLA35383
ARMADO MF	PLA35697
MODULO BL	PLA35376
MODULO MF	PLA35734



Jack Teléfono Simple RJ14

ARMADO BL	PLA35284
ARMADO MF	PLA35277
MODULO BL	PLA35253
MODULO MF	PLA35260

Jack Datos Doble CAT6

ARMADO BL	PLA35390
ARMADO MF	PLA35703



Placa Ciega

ARMADO BL	PLA31480
ARMADO MF	PLA35499



Jack Teléfono Doble RJ14

ARMADO BL	PLA35307
ARMADO MF	PLA35291

Tomacorriente Doble GFCI

ARMADO BL	PLA36434
ARMADO MF	PLA36441

Tomacorriente Univ + Tomacorriente Italiano

ARMADO BL	PLA36823
ARMADO MF	PLA36830



Tomacorriente Zhuko 16 Amp

ARMADO BL	PLA90405
ARMADO MF	PLA90412



Tomacorriente Nema 6-15R

ARMADO BL	PLA35963
ARMADO MF	PLA35970



Conector Parlante Simple

ARMADO BL	PLA35789
ARMADO MF	PLA35802



Conector Parlante Doble

MODULO BL	PLA35796
MODULO MF	PLA35819



Tomacorriente Univ. Sin Tierra + USB

ARMADO BL	PLA36526
ARMADO MF	PLA36533

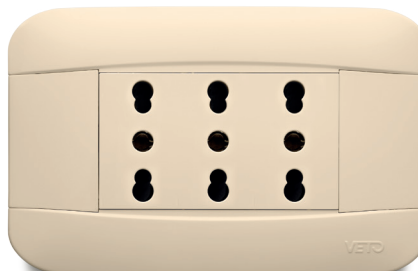

Tomacorriente Triple Italiano

MODULO BL	PLA36779
MODULO MF	PLA36809



Tomacorriente Simple Univ. Sin Tierra

ARMADO BL PLA35994
ARMADO MF PLA35987



Tomacorriente Doble Univ. Sin Tierra

ARMADO BL PLA35864
ARMADO MF PLA35710



Tomacorriente Simple Univ. Con Tierra

ARMADO BL PLA35826
ARMADO MF PLA35840



Tomacorriente Univ Con Tierra + Interruptor Sin Luz

ARMADO BL PLA35888
ARMADO MF PLA35871



Tomacorriente Univ Sin Tierra + Interruptor Sin Luz

ARMADO BL PLA35895
ARMADO MF PLA35956



Tomacorriente Simple Tipo Italiano

ARMADO BL PLA36762
ARMADO MF PLA36793



veto[®]



 [®]
Vive

www.vetoelectric.com



CARACTERÍSTICAS

- Sistema modular (Tacos y Placas)
- Contactos con punto de Plata
- Interruptores 125/250 Vac 10 Amp
- Tomacorrientes 125/250 Vac 15 Amp
- La luz piloto de nuestros productos no produce destellos al utilizarse con focos ahorradores

CERTIFICACIONES

- Certificación que cumple con la Norma IEC 60669-1 (Interruptores)
- IEC 60884-1 (Tomacorrientes)

DIAGRAMA DE INSTALACIÓN

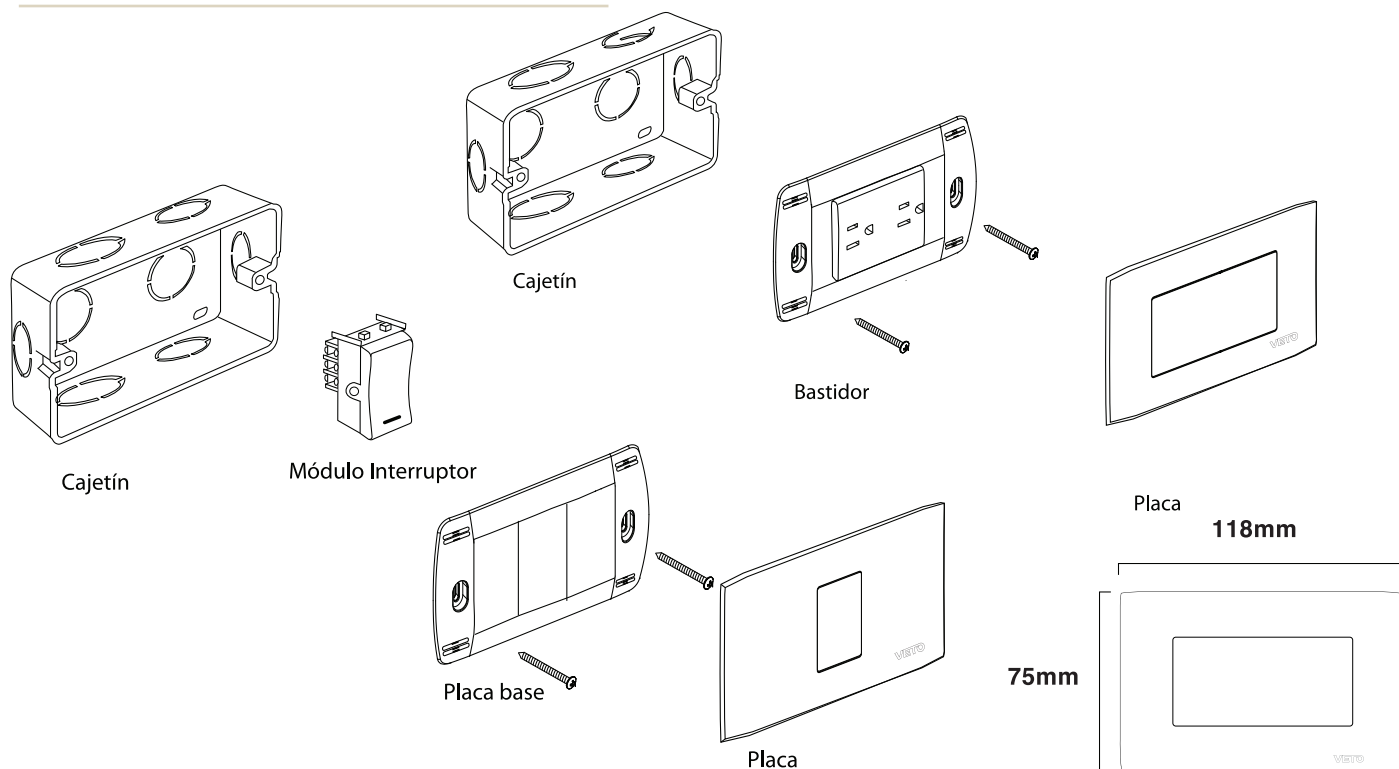



Placa 1 Hueco

BL	VIV13701
MF	VIV14074

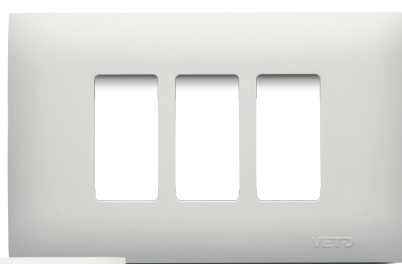

Placa 3 Huecos

BL	VIV13725
MF	VIV14098

Placa 2 Huecos

BL	VIV13718
MF	VIV14081

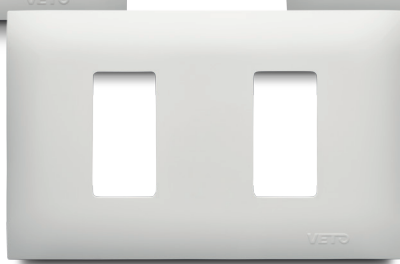

Interruptor con Luz Piloto Simple 10 Amp

ARMADO BL	VIV13008
ARMADO MF	VIV13237
MODULO BL	VIV13572
MODULO MF	VIV13947

Conmutador

ARMADO BL	VIV13039
ARMADO MF	VIV13268
MODULO BL	VIV13534
MODULO MF	VIV13909



Interruptor Simple 10 Amp

ARMADO BL	VIV13060
ARMADO MF	VIV13299
MODULO BL	VIV13589
MODULO MF	VIV13954

Conmutador

ARMADO BL	VIV13091
ARMADO MF	VIV13329
MODULO BL	VIV13541
MODULO MF	VIV13916

Interruptor con Luz Piloto Doble 10 Amp

ARMADO BL	VIV13015
ARMADO MF	VIV13244

Conmutador

ARMADO BL	VIV13046
ARMADO MF	VIV13275

Interruptor + Conmutador

ARMADO BL	VIV13633
ARMADO MF	VIV13992

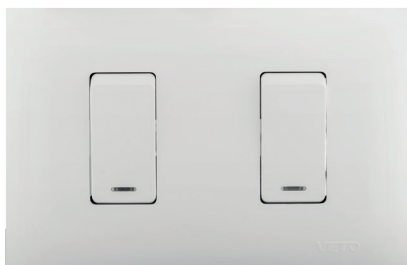

Interruptor Doble 10 Amp

ARMADO BL	VIV13077
ARMADO MF	VIV13305

Conmutador

ARMADO BL	VIV13107
ARMADO MF	VIV13336

Interruptor + Conmutador

ARMADO BL	VIV13626
ARMADO MF	VIV14005

Interruptor con Luz Piloto Triple 10 Amp

ARMADO BL	VIV13022
ARMADO MF	VIV13251

Conmutador

ARMADO BL	VIV13053
ARMADO MF	VIV13282

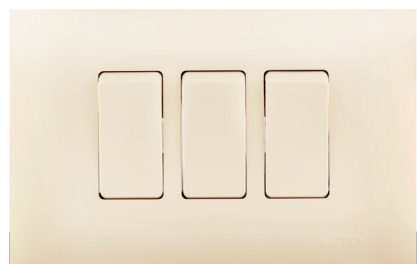
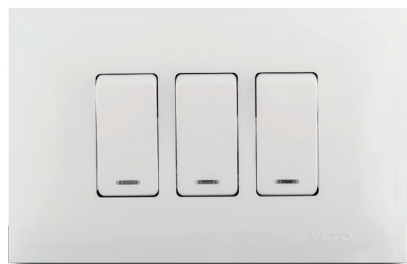

Interruptor Triple 10 Amp

ARMADO BL	VIV13084
ARMADO MF	VIV13312

Conmutador

ARMADO BL	VIV13114
ARMADO MF	VIV13343

Tomacorriente Doble

ARMADO BL	VIV13206
ARMADO MF	VIV13435

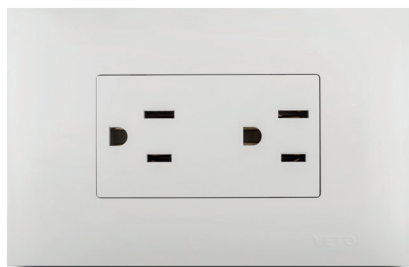

Tomacorriente Doble tierra aislada

ARMADO	VIV14203
--------	----------

Tomacorriente + Interruptor con Luz Piloto

ARMADO BL	VIV13121
ARMADO MF	VIV13350
TOMACORRIENTE BL	VIV13794
TOMACORRIENTE MF	VIV14166
INTERRUPTOR BL	VIV13572
INTERRUPTOR MF	VIV13947

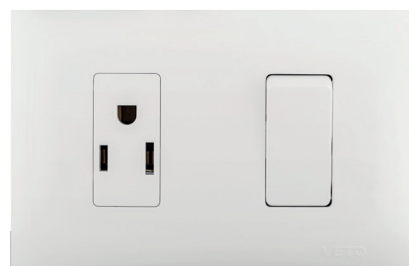
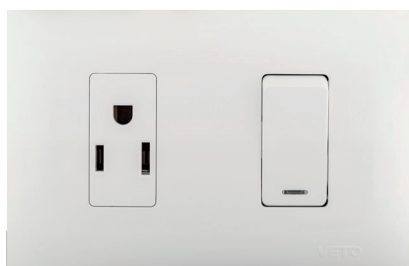

Tomacorriente + Interruptor

ARMADO BL	VIV13138
ARMADO MF	VIV13367
INTERRUPTOR BL	VIV13589
INTERRUPTOR MF	VIV13954

Jack Teléfono Simple RJ14

ARMADO BL	VIV13169
ARMADO MF	VIV13398
MODULO BL	VIV13619
MODULO MF	VIV13985

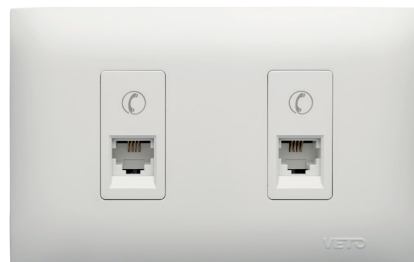
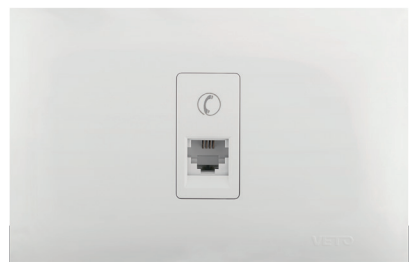

Jack Teléfono Doble RJ14

ARMADO BL	VIV13176
ARMADO MF	VIV13404
MODULO BL	VIV13619
MODULO MF	VIV13985

Dimmer 200W

ARMADO BL	VIV13565
ARMADO MF	VIV13930
MODULO BL	VIV13558
MODULO MF	VIV13923

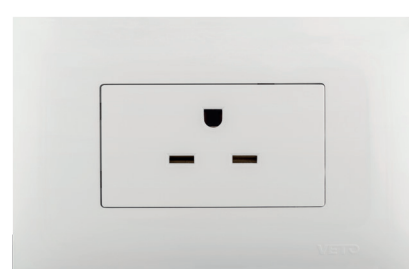

Tomacorriente Nema 6-15R

ARMADO BL	VIV13220
ARMADO MF	VIV13459



Pulsador de Timbre con Luz Piloto

ARMADO BL	VIV13145
ARMADO MF	VIV13374
MODULO BL	VIV13732
MODULO MF	VIV14104



Pulsador de Timbre

ARMADO BL	VIV13152
ARMADO MF	VIV13381
MODULO BL	VIV13749
MODULO MF	VIV14111



Coaxial + Jack Teléfono

ARMADO BL	VIV13640
ARMADO MF	VIV14012
COAXIAL BL	VIV13497
COAXIAL MF	VIV13862
JACK BL	VIV13619
JACK MF	VIV13985

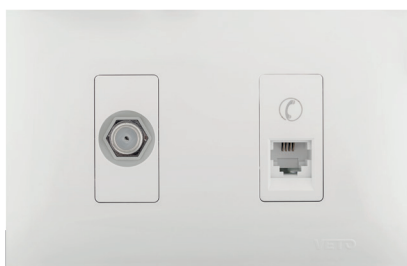

Coaxial 75 Ohms

ARMADO BL	VIV13183
ARMADO MF	VIV13411
MODULO BL	VIV13497
MODULO MF	VIV13862



Jack Datos Simple CAT6

ARMADO BL	VIV13213
ARMADO MF	VIV13442
MODULO BL	VIV13596
MODULO MF	VIV13961



Jack Datos Doble CAT6

ARMADO BL	VIV13602
ARMADO MF	VIV13978

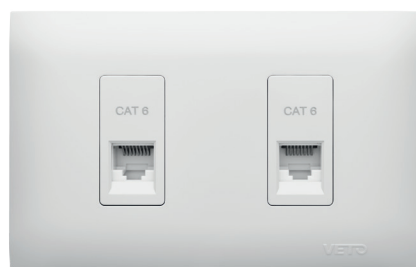

Pasa Cable

ARMADO BL	VIV14210
ARMADO MF	VIV14227



Placa Ciega

ARMADO BL	VIV13190
ARMADO MF	VIV13428

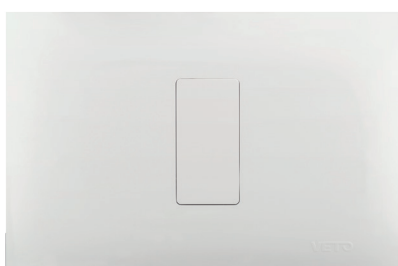

Tomacorriente Universal Simple

ARMADO BL VIV13787
ARMADO MF VIV14159



Tomacorriente Universal Doble

ARMADO BL VIV13824
ARMADO MF VIV14197



Tomacorriente Universal Doble

ARMADO BL VIV13817
ARMADO MF VIV14180



Tomacorriente Universal + Interruptor con luz piloto

ARMADO BL VIV13671
ARMADO MF VIV14043

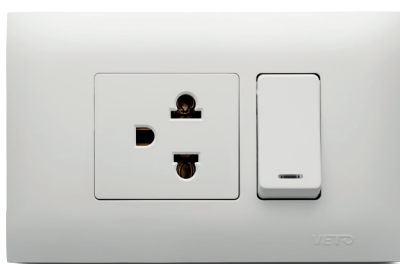

Tomacorriente Universal + Interruptor sin luz piloto

ARMADO BL VIV13688
ARMADO MF VIV14050

Tomacorriente + Interruptor con Luz Piloto

ARMADO BL VIV13657
ARMADO MF VIV14029



Tomacorriente 2P + Interruptor sin Luz Piloto

ARMADO BL VIV13664
ARMADO MF VIV14036

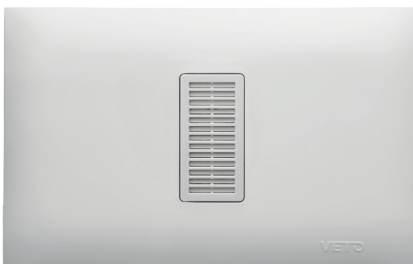

Zumbador

Próximamente

Conector Parlante Simple

ARMADO BL VIV13527
ARMADO MF VIV13893



Conector Parlante Doble

ARMADO BL VIV13510
ARMADO MF VIV13886

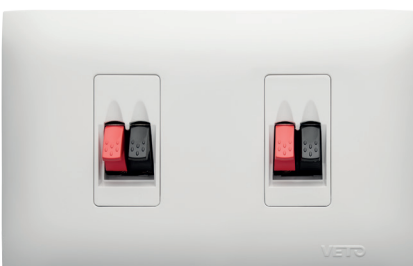



Apagador

BL	VIP12001
MF	VIP12087

Apagador de escalera sencillo

BL	VIP12032
MF	VIP12117

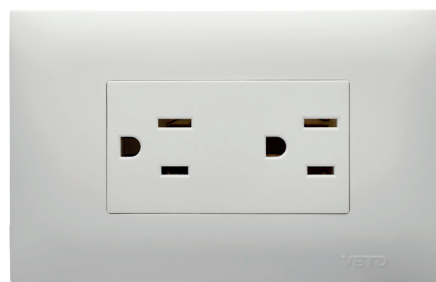

Contacto Dúplex

ARMADO BL	VIP12070
ARMADO MF	VIP12155

Apagador

BL	VIP12018
MF	VIP12094

Apagador de escalera doble

BL	VIP12049
MF	VIP12124



Contacto + Apagador

ARMADO BL	VIP12063
ARMADO MF	VIP12148



Apagador

BL	VIP12025
MF	VIP12100

Apagador de escalera triple

BL	VIP12056
MF	VIP12131





CARACTERÍSTICAS

- Sistema modular (Tacos y Placas)
- Sistema de luz piloto LED
- Interruptores 125/250 Vac 16 Amp
- Tomacorrientes 125/250 Vac 15 Amp
- Termopolímero de última generación

CERTIFICACIONES

- Certificación que cumple con la Norma IEC 60669-1 (Interruptores)
- IEC 60884-1 (Tomacorrientes)
- CCC
- CE
- UL
- GB 16915,1-97



DIAGRAMA DE INSTALACIÓN

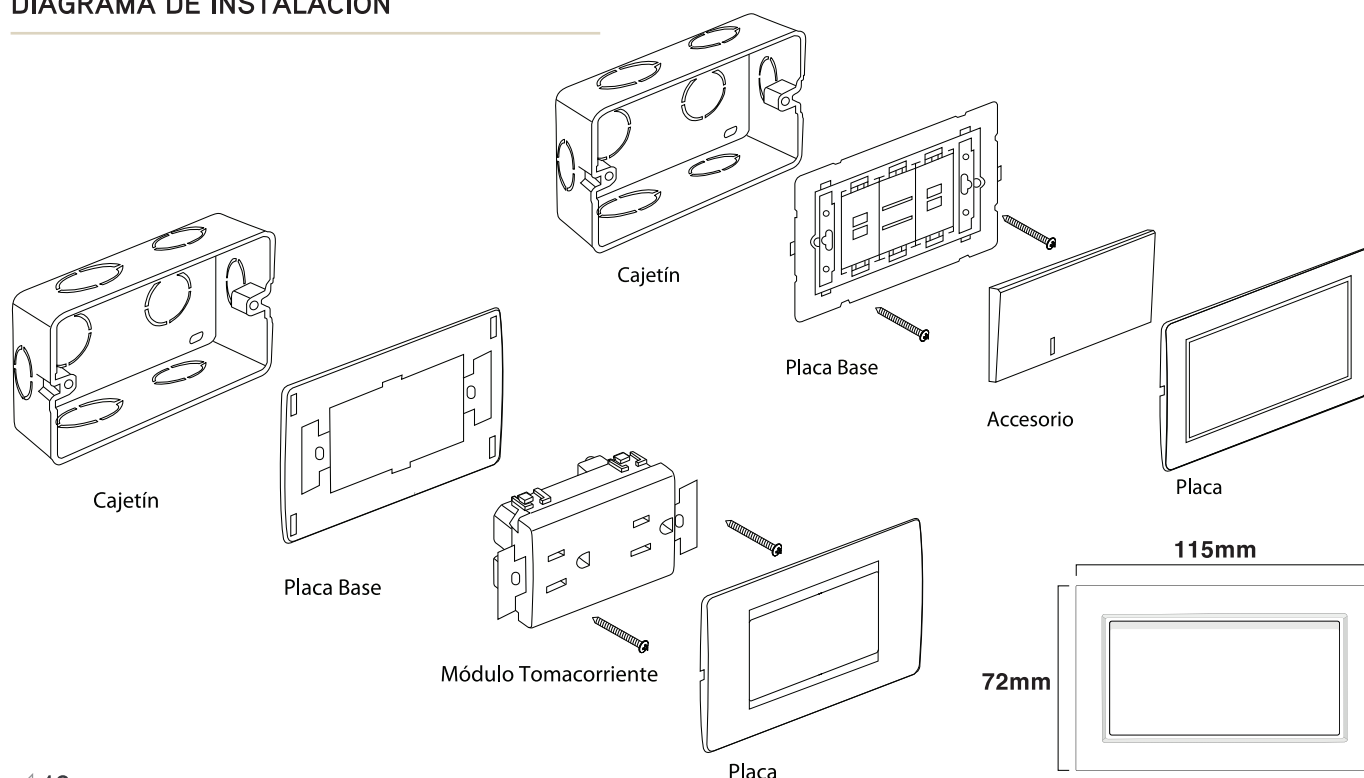

Interruptor Simple 16 Amp
con luz LED

NIE17723

Conmutador Simple
con Luz LED

NIE17716

Conmutador de 4 Vías

NIE17341



Interruptor Doble 16 Amp
con Luz LED

NIE17686

Conmutador Doble
con Luz LED

NIE17679

Interruptor Triple 16 Amp
con luz LED

NIE17709

Conmutador triple
con luz LED

NIE17693

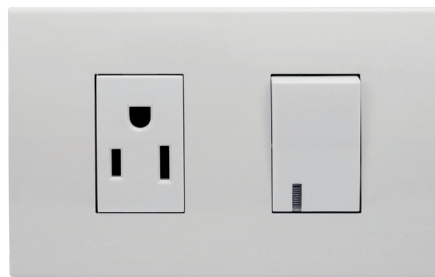

Interruptor + Toma 2P+E

NIE17204

Jack de Datos Cat 5E

NIE17228



Jack de Datos + Coaxial

NIE17044

Pulsador de Timbre

nie17662



Dimmer

NIE17563

Tomacorriente Doble Univ
NIE17518

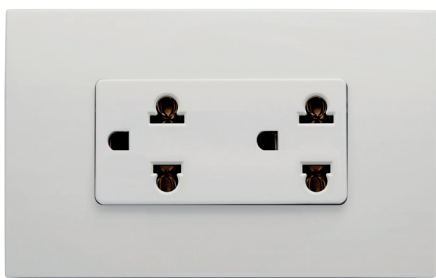

Tomacorriente Doble 2P+E
NIE17518

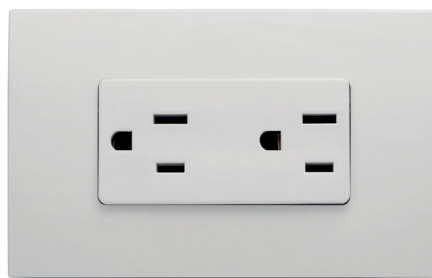

Placa Ciega
NIE17969



Placa
NIE17310



Placa 1 Hueco
NIE17969



Placa 2 Huecos
NIE17617



Toma Audio + Video
NIE17778

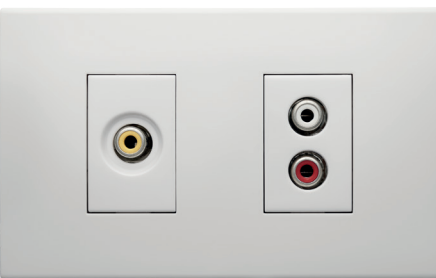

Coaxial
NIE17235



veto[®]



®

Click

www.vetoelectric.com



CARACTERÍSTICAS

Soluciones sobrepuestas

Contactos con punto de Plata

Interruptores 125/250 Vac 10 Amp

Pulsadores 125/250 Vac 10 Amp

Conmutadores 125/250 Vac 10 Amp

Tomacorrientes 125/250 Vac 15 Amp



CERTIFICACIONES

Certificación que cumple con la Norma IEC60898-1

DIAGRAMA DE INSTALACIÓN

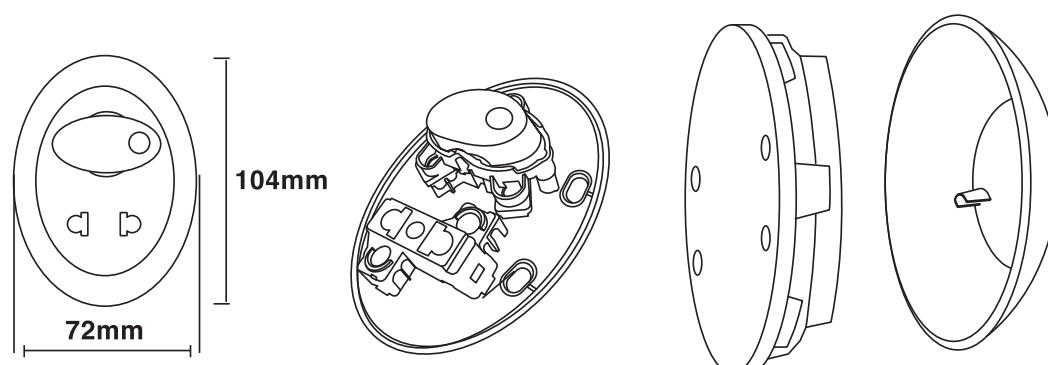
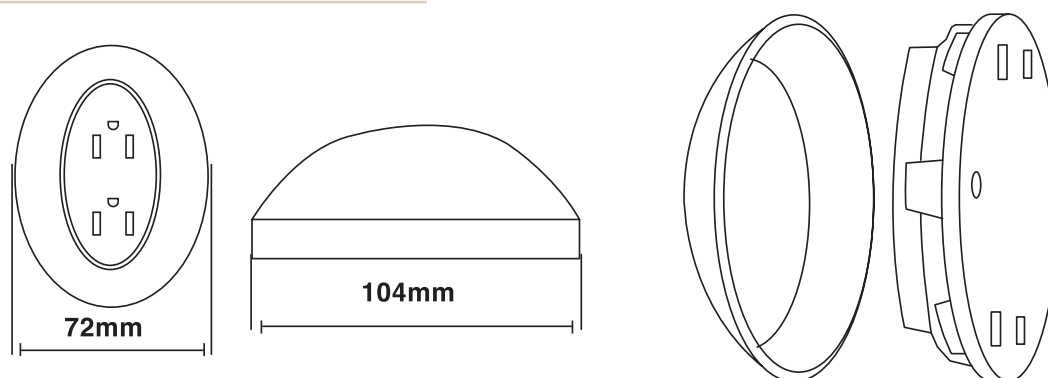



Click



Interruptor

BL	CLI20006
MF	CLI20037

Conmutador

BL	CLI20013
MF	CLI20044



Pulsador Timbre

BL	CLI20020
MF	CLI20051

Interruptor 32 Amp.

BL	CLI20242
----	----------



Tomacorriente Simple Univ

BL	CLI20204
MF	CLI20211

Tomacorriente Doble Univ

BL	CLI20082
MF	CLI20099



Tomacorriente Doble Univ

BL	CLI20068
MF	CLI20075

Tomacorriente Triple Univ

BL	CLI20228
MF	CLI20235

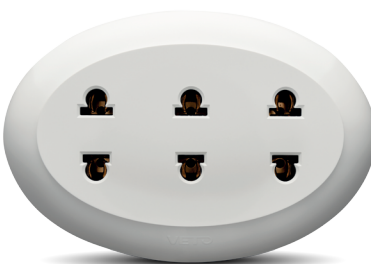

Tomacorriente Univ + Interruptor

BL	CLI20181
MF	CLI20198

veto[®]



Accesorios



Portalámpara/Plafón

BL ACC43036
MF ACC43029

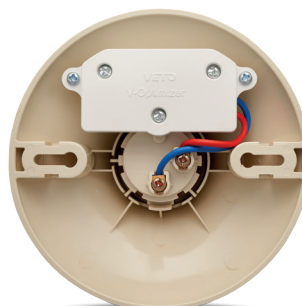

Portalámpara + V-Optimizer

BL ACC43043
MF ACC43050

Clavija 50 Amp

ACC43203



Clavija 20 Amp

ACC43210



V-Optimizer

ACC90344



Ding Dong

ACC89003



Regleta 6 Tomacorrientes + 2 USB

ACC90351



Regleta 6 Tomacorrientes

ACC90368





Socker de Piso
ACC90252



Socker de Piso
ACC90276



Socker de Piso HD
ACC90634

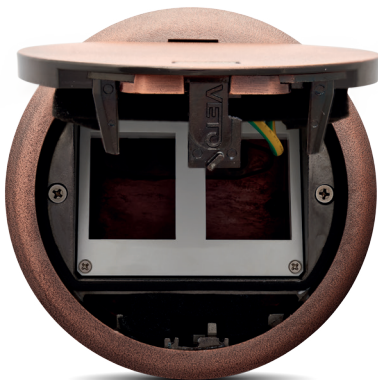

Socker de Piso HD
ACC90641



Socker de Piso TL
ACC90610



Socker de Piso TL
ACC90627



veto[®]



®

Power

www.vetoelectric.com

CARACTERÍSTICAS

Sellado y resistente al agua y humedad iP 6 5
 Protección Termomagnética contra corto circuitos
 y sobrecargas
 25, 32, 40, 50, 63 Amp
 Termopolímero de última generación
 10 Años de garantía Internacional.

CERTIFICACIONES

Certificación que cumple con la
 Norma IEC60898-1



DIAGRAMA DE INSTALACIÓN

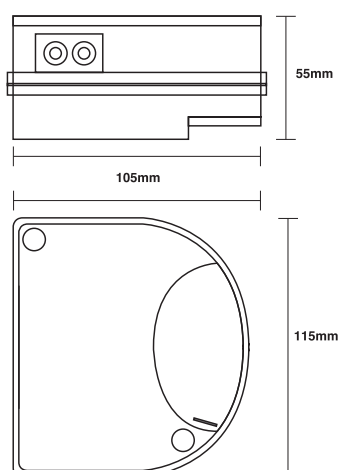
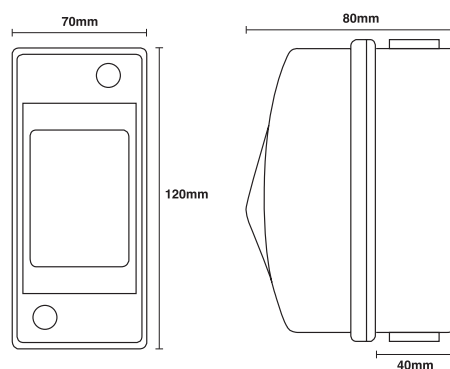
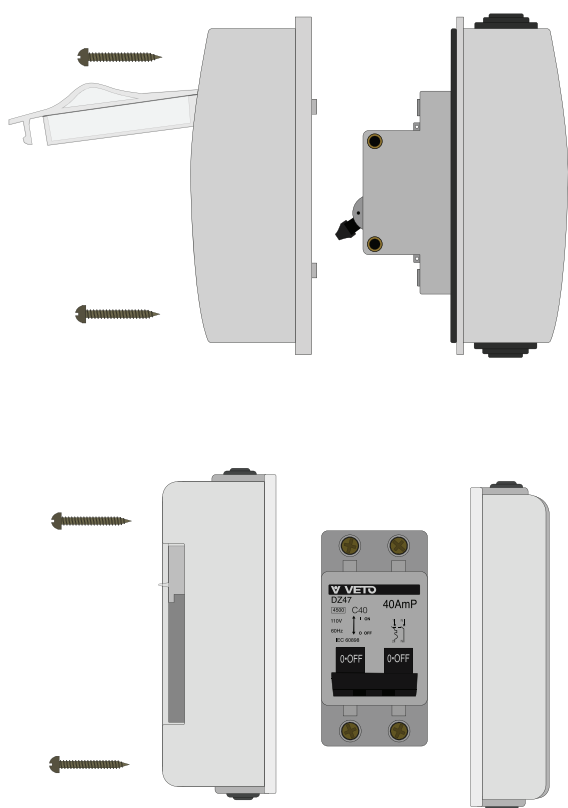



**Interrupor
Termomagnético**
25AmP POW25018



**Interrupor
Termomagnético**
32AmP POW32030



**Interrupor
Termomagnético**
40AmP POW40004



**Interrupor
Termomagnético**
50AmP POW50003



**Interrupor
Termomagnético**
63AmP POW63003



**Interrupor
Termomagnético**
32AmP POW32016
40AmP POW40028
50AmP POW50027
63AmP POW63027





10
años
Garantía

veto®

VETO GLOBAL SOURCING LTD
UNIT 1104a, 11/f, KAI TAK COMM.
BLDG, 317-319 DES VOEUX RD,
CENTRAL, Hong Kong

CONTACTOS

maklatam@vetoelectric.com
manuel.tobar@vetoelectric.com

 Veto Electric

 veto_electric

 Veto Electric

www.vetoelectric.com

veto®